



WKB V6 Wireless Handheld Controller
User Manual

Shanghai Friendess Electronic Technology Corporation. Ltd.

www.fscut.com

Ver1.0



Preface

Thank you for choosing our products!

This manual gives a detailed introduction of WKB V6 wireless handheld controller, including product characteristics, installation and operation instructions, etc. For laser cutting software operation, please refer to the software Help documents. For other matters you can contact us directly.

Operating personnel should read the manual in detail which will be helpful for a better use of the product.

Due to continuous updating of product functions, the products you receive may differ from the statement in this manual in some respects. We apologize for any inconvenience it may cause.



Contents

1. Product Description.....	4
1.1 Brief Introduction	4
1.2 Connection Diagram.....	4
1.3 Technical Reference.....	5
1.4 WKB V6 Installation	5
1.4.1 Install Steps.....	5
1.4.2 Troubleshooting.....	8
2. Operation Instructions:.....	9
2.1 Button Instructions.....	9
2.1.1 Dedicated Button.....	9
2.1.2 User-defined Button	13
2.1.3 Status Indicator	13
2.2 Power Supply	13



1. Product Description

1.1 Brief Introduction

WKB V6 is a high-performance handheld controller widely used in laser cutting application independently developed by Shanghai Friendess Electronic Technology Co., Ltd. The controller has an extensive popularity for its easy-to-use and excellent capabilities.

Please read through this manual after you received the product.

The accessories contained:

Name	Model	Qty.
Wireless Controller	WKB V6 Handheld Controller	1 pcs
Receiver	USB receiver	1 pcs

1.2 Connection Diagram

WKB V6 receiver adopts USB interface, dimension 175mm * 80mm. Wiring diagram shown below:

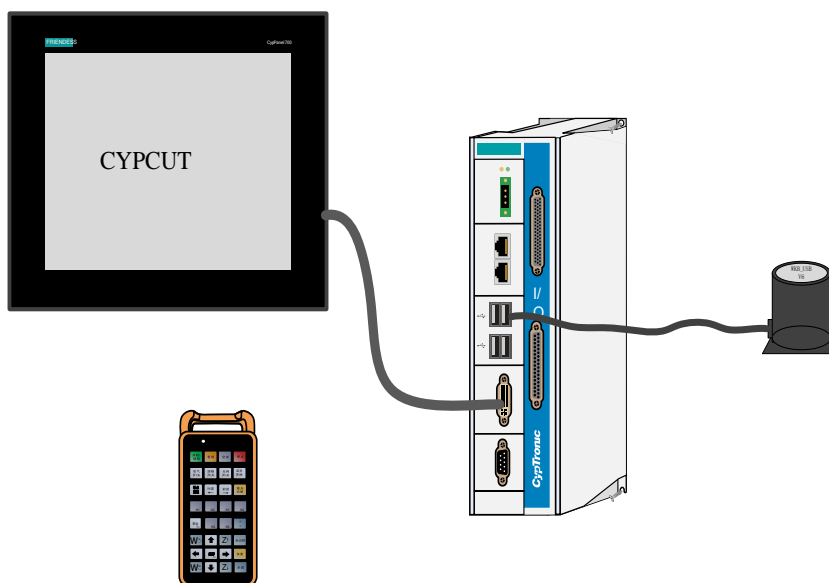



1.3 Technical Reference

Button	Button qty.	26 special buttons
		6 custom buttons
	Button life	Million times
Work environment		Temperature:0-55 Celsius degree
		Humidity:5% ~ 90% without condensation
Power supply		Two 1.5V dry batteries

1.4 WKB V6 Installation

1.4.1 Install Steps



Please wear anti-static gloves to prevent possible electrostatic damage to the product.

- (1) The overall dimension of WKB V6 is shown in the following figure (unit: mm):



Figure 1 Dimension of main body1

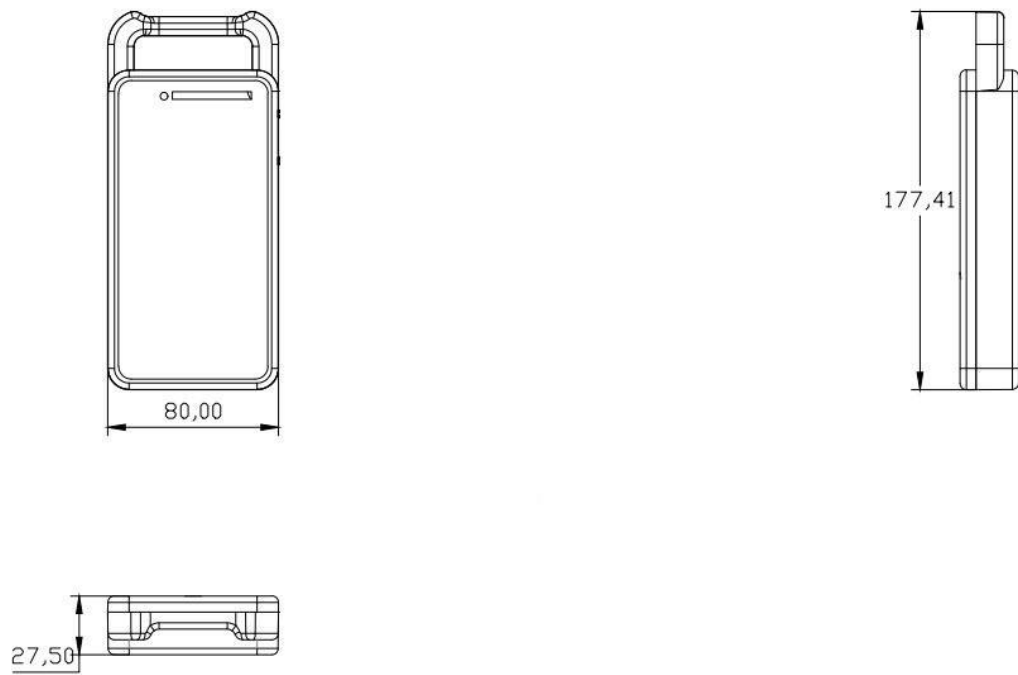
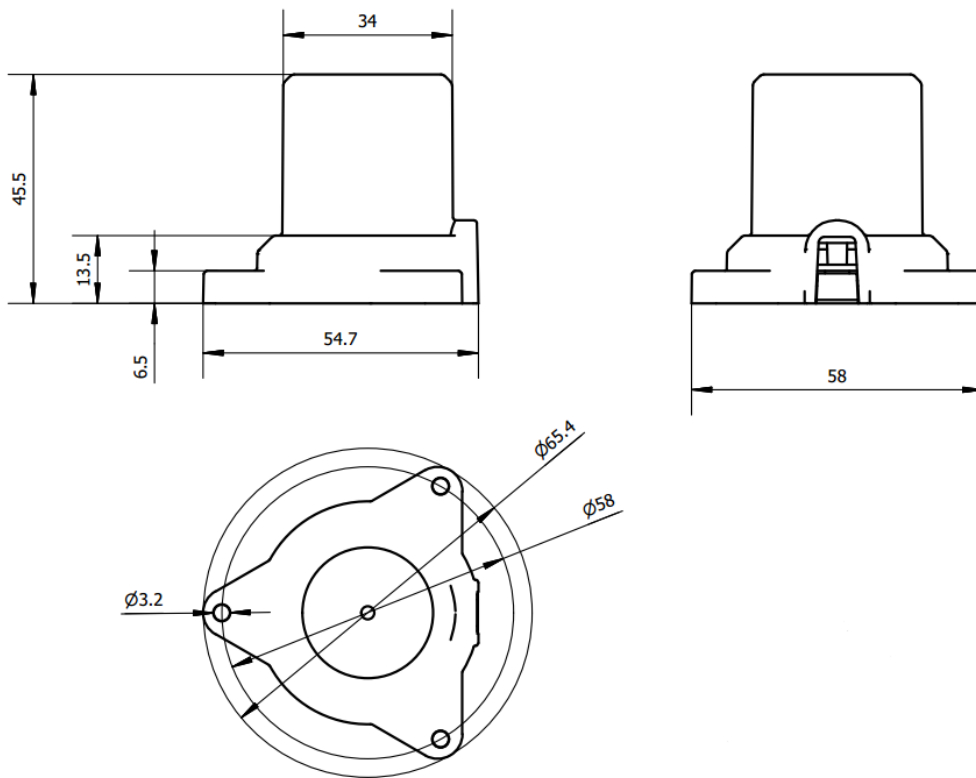



Figure 2 Dimension of receiver2





(2) USB receiver extension cable

Connect extension cable to PC USB port.

(3) Wireless Controller

Slide power switch to ON position. Press any button on handheld controller, green LED lights on.

(4) Open laser cutting software and press button on WKB, machine will execute the command function.

1.4.2 Troubleshooting

(1) If controller runs out of battery.

Turn on power switch then press any button, if green LED indicator turns to red light and flashes, this indicates low battery warning.

(2) USB receiver should be placed inside or outside electrical cabinet?

The communication distance can reach longer than 50 meters. So put receiver inside cabinet won't affect communication quality. But if the electrical cabinet is all-metal structure, it's recommended to put receiver outside cabinet to prevent electrical interference.

(3) If using long USB extension cable.

USB extension cable too long will cause signal attenuation and communication breakoff. It is not recommended to use a long USB extension cable to connect receiver. The effective distance of USB protocol is 5 meters, longer USB extension cable can also work but requires a good quality of the cable. Effective distance of poor USB extension cable cannot reach 5m. If a USB extension cable must be used, active USB extension cable is recommended.



2. Operation Instructions:



WKB V6 handheld controller has 1 power switch, 32 function buttons and 1 status indicator. Product image shown below:













2.1 Button Instructions

There are 32 buttons on WKB V6 in total, of which 26 buttons are with dedicated function, 6 buttons are with customized function.











2.1.1 Dedicated Button

Button Instructions	Function description
	Press the button to start machining; Press the button to resume machining after pausing.
	Press the button to pause the machining.













	<p>Press the button to run the machining path with laser off.</p>
	<p>Press the button to stop machining process and return to start position.</p>
	<p>Press the button to blow gas; press again turn off gas.</p>
	<p>Press the button laser head will follow to plate and keep a pre-set distance with plate surface; press again turn off follow function.</p>
	<p>Press the button turn on laser shutter; press again turn off shutter.</p>
	<p>Press the button turn on guide laser; press again turn off guide laser.</p>
	<p>Press the button to locate to the interrupted position of last machining task.</p>
	<p>Single-press the button to step backward a pre-set distance along cutting path.</p>
	<p>Single-press the button to step forward a pre-set distance along cutting path.</p>
	<p>Press the button to burst laser; release the button stop bursting laser.</p>



	User-defined button
	User-defined button
	User-defined button
	User-defined button
	User-defined button
	User-defined button
	Press the button will start 'find plate edge' function.
	For a composite-function button you have to press it with Fn button together.
	Clockwise rotation
	Counterclockwise rotation



	Move forward
	Laser head move upward.
	Press the button machine will run a rectangle path framing the cutting area according current graph.
	Move left
	Press the button machine will return to graph zero point.
	Move right
	Press the button together with direction button machine will move in pre-set 'Jog high speed'.
	Move backward.
	Laser head moves downward.
	Single-press the button machine will move a pre-set 'step distance'.



2.1.2 User-defined Button

WKB V6 has 6 custom buttons for user to define function required.

2.1.3 Status Indicator

WKB V6 wireless handheld controller has one status indicator. It serves two functions: the green light indicates button pressed; red light indicates batteries run out.

2.2 Power Supply

The power supply of WKB V6 are two dry batteries of 1.5V.